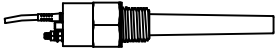

Table of contents

	Page
Specifications/ Application	2

CN 7100 	3

Options	4
Accessories	4
Detailed Ex-markings	4
Dimensions	5
Electrical installation	6

Subject to change.

All dimensions in mm (inches).

All prices in Euro (€) or USD (\$),
 excluding VAT.

All EURO prices are EXW Betzigau,
 all USD prices are EXW Memphis,
 excluding packaging costs.

Valid: From 01.01.2019 until 31.03.2020, unless otherwise agreed.

By publishing this selection list all other lists become invalid.

We assume no liability for typing errors.

Different variations to those specified are possible.
 Please contact our technical consultants.

Specifications

- Level limit detection in liquids, slurries, foam, interfaces and solids
- Compact unit
- Wide range of applications
- No maintenance
- Full-, demand-, empty detector
- Integral cable version or Enclosure version
- Corrosion resistant construction
- Capacitive technology
- Sensitivity: dielectric constant ≥ 1.5
- 2-wire 4/ 20 mA switch
- Non-polarized, solid-state switch or relay output
- FSL/ FSH selectable
- 2011/65/EU RoHS conform

Approvals	CE	
	ATEX	Intrinsically Safe
	FM/CSA	Intrinsically Safe
	INMETRO	Intrinsically Safe
	TR-CU	Ordinary Locations, Intrinsically Safe
	WHG	Overfill protection

Electronics	Power supply	12 - 33 V DC ⁽²⁾
	Output	4/ 20 mA or 20/ 4 mA, 2-wire current loop detection Solid-state switch 30 V DC max, Relay 60 V DC or 30 V AC max ⁽²⁾

(2) Reduces values present for intrinsically safe version and for wet locations

		Integral cable version	Enclosure version
Mechanics and Process	Housing/ lid	316L stainless steel	VALOX® (thermoplastic polyester)/ PC (polycarbonate) transparent
	Ingress protection	Type 4/ NEMA 4/ IP65	Type 4/ NEMA 4/ IP68
	Length of extension	120 mm (4.7")	120 mm (4.7")
	Ambient temperature	-30 .. +85°C (-22 .. +185°F)	-10 .. +85°C (+14 .. +185°F) with PPS process connection -30 .. +85°C (-22 .. +185°F) with SS process connection
	Process temperature	-30 .. +100°C (-22 .. +212°F) With ATEX approval: -30 .. +85°C (-22 .. +185°F)	With PPS process connection: -10 .. +100°C (+14 .. +212°F) With stainless steel process connection: -30 .. +100°C (-22 .. +212°F) With ATEX approval: -30 .. +85°C (-22 .. +185°F)
	Process pressure	-1 .. 10 bar (146 psi) gauge, nominal	-1 .. 10 bar (146 psi) gauge, nominal
	Process connection	Stainless steel 1.4404 (316L): $\frac{3}{4}$ " NPT or R 1" (BSPT) or G 1" (BSPP)	Stainless steel 1.4404 (316L): $\frac{3}{4}$ " NPT or R 1" (BSPT) or G 1" (BSPP) PPS (Fully synthetic): $\frac{3}{4}$ " NPT or R 1" (BSPT)
	Material of sensor	PPS or PVDF	PPS or PVDF
	Material of seal (probe)	FKM or FFKM	FKM or FFKM
	Connecting cable	1 m (3.3 ft) of 4 conductor, 22 AWG, shielded, polyester jacket	-

Applications

Vertical

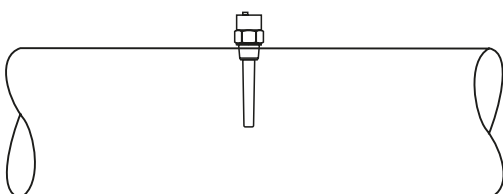

Angle

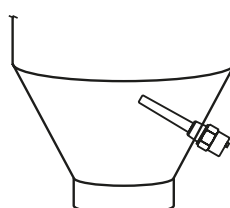

Horizontal

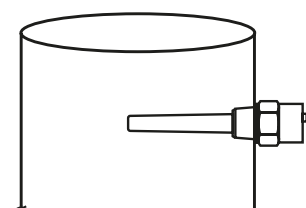

CN 7100



Integral cable version



Enclosure version

Dimensions: see page 5
Cable entries: M20 x 1.5 (1x cable gland, attached) for Process connection R and G
 NPT 1/2" (1x open conduit) for Process connection NPT
 Options see page 4

Basic type

CN 7100 •

pos.2 **Certificate** (detailed Ex-markings: see page 4)

	Gas	Dust	Protection method		
0	CE	-	-	General purpose	• •
Q	CE/ FM/ CSA ⁽¹⁾	-	-	General purpose	• •
Y	ATEX/ FM/ CSA ^(2, 3)	Zone 0 and 0/1, Cl. I Div.1	Zone 20 and 20/21, Cl. II, III, Div.1	Intrinsically Safe	• •
B	INMETRO ⁽³⁾	Zone 0	Zone 21	Intrinsically Safe	• •

pos.3 **Device version**

- 1 Integral cable • •
- 2 Enclosure • •

pos.4 **Electronic module**

- A 2-wire 4/ 20 mA, solid state or relay switch ⁽⁴⁾ • •

pos.5 **Material of sensor**

- A PPS • •
- B PVDF • •

pos.6 **Process connection**

- A Thread 3/4" NPT • •
- E Thread R 1" • •
- J Thread G 1" • •

pos.7 **Material of process connection**

- 1 PPS ↑
- 2 Stainless steel 1.4404 (316L) ↑

Further options: see page 4

- (1) Included is: TR-CU (Ordinary Locations)
- (2) Included is: TR-CU
- (3) Intrinsically safe barrier required
- (4) Implemented is relay switch with PPS (pos.7 1), solid state switch with stainless steel (pos.7 2)

CN 7100 A A ← **Order code**

Position 1 2 3 4 5 6 7

All positions are available with special design (use code "Z").

Options / Accessories

Options

- pos.11 x **Guarantee extension to 5 years** •
- pos.17 x **FFKM wetted seals** ⁽¹⁾ •
- pos.23 x **WHG approval** •
- pos.25 x **Inspection certificate** •
 Type 3.1 (EN 10204)
- pos.30 x **Stainless steel tag** •
 Measuring point number/ identification (max. 27 characters)

Cable entry ⁽²⁾

Selection of the following options only necessary, if a deviation from the default cable entry is required:

- pos.33 x M20 x 1.5 (1x cable gland, attached) •
- pos.33 a NPT ½" tapered ANSI B1.20.1 (1x open conduit) •

Accessories

Minimum order value for spare parts or accessories is 75 €.

- cl440102 Sensguard (PPS) Process connection ¾" NPT ⁽³⁾ •
- cl440103 Sensguard (PPS) Process connection 1" BSPT ⁽³⁾ •
- em440318 Plug M12 (without mating plug), 4-pole, max. 25 V ⁽⁴⁾ •
- em440319 Plug M12 (without mating plug), 5-pole (incl. PE), max. 60 V ⁽⁴⁾ •

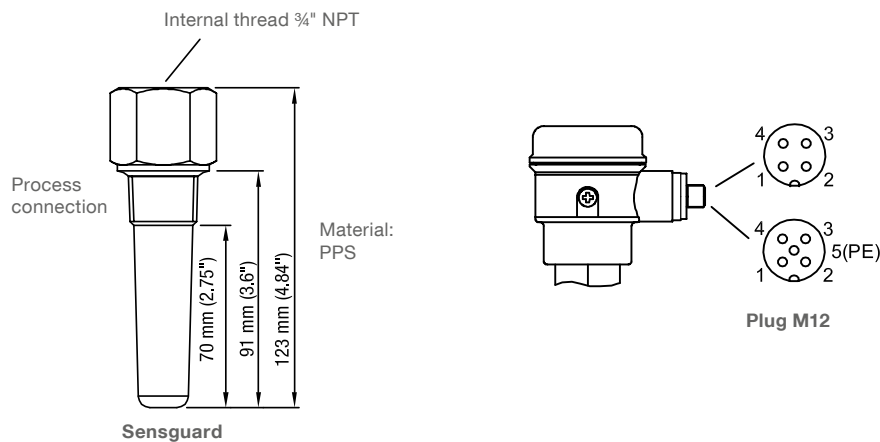

(1) Not available with PPS process connection (pos.7 1). Process temperature limited to -20°C (-4°F).
 (2) Available with Device version Enclosure (pos.3 2)
 (3) Requires unit with process connection ¾" NPT (pos.6 A)
 (4) Available for CE (pos.2 0). Connection of plug wires to internal terminals by customer.

Detailed Ex-markings

Certificate

pos.2	Y	ATEX II 1 G Ex ia IIC T6...T4 Ga ATEX II 1/2 G Ex ia IIC T6...T4 Ga/Gb ATEX II 1 D Ex ia IIIC T ₂₀₀ 130°C Da ATEX II 1/2 D Ex ia IIIC T ₂₀₀ 130°C Da/Db FM IS Cl. I, II, III Div.1 Gr. A-G CSA Cl. I, II, III Div.1 Gr. A-G Intrinsic safe
pos.2	B	INMETRO Ex ia IIC T6 Ga, Ex tb IIIC T62 °C Db, IP68 Ta ≤ +40 °C Ex ia IIC T4 Ga, Ex tb IIIC T107 °C Db, IP68 Ta ≤ +85 °C

Dimensions

Integral Cable version

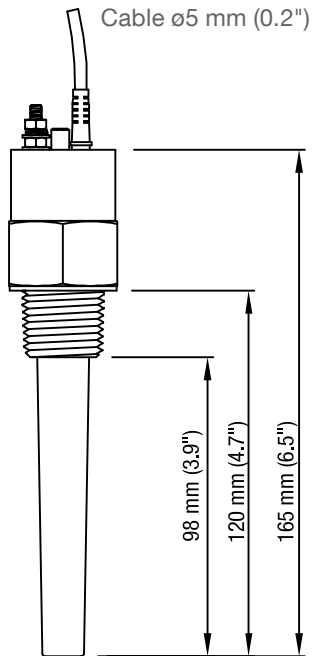

3/4" NPT: 36 mm (1.4")
 R 1": 36 mm (1.4")
 G 1": 41 mm (1.6")

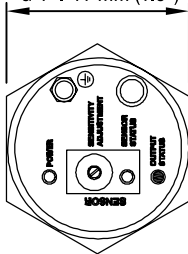

Enclosure version

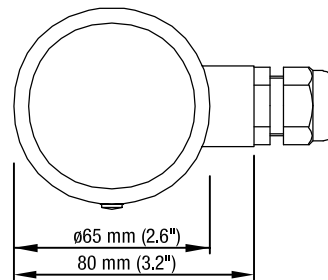
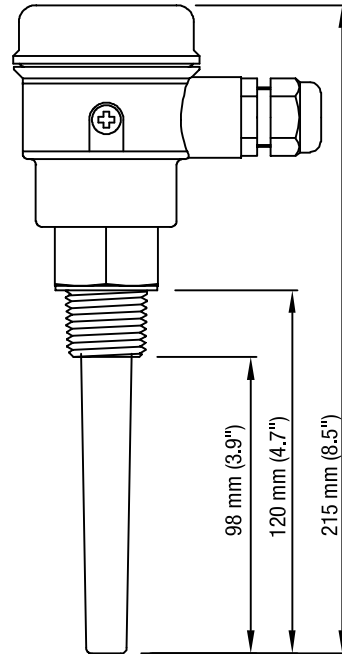

Electrical installation

Integral Cable Version

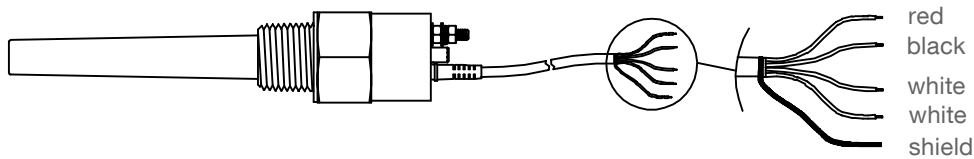

Operation with solid state switch/ relay

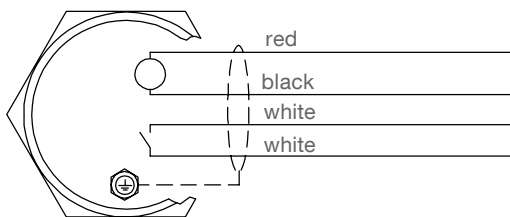

Shield is internal connected to ground.
 It is recommended to use a shielded cable for stable measurement.

red/ black	white/ white
Supply: 12 - 33 V DC 10 - 30 V DC intrinsic safe*	Output: Solid state switch* Observe protection (see below). Max. 30 V DC/ 30 V AC, 82 mA Limited to 30 V DC/ 16 V AC, 82 mA in wet locations.
Polarity determines output logic, see table below	
* For intrinsic safe operation an intrinsic safety barrier is required. Ratings U_i I_i P_i C_i L_i of power supply and solid state switch: see instruction manual.	

Operation with 4/ 20 mA loop

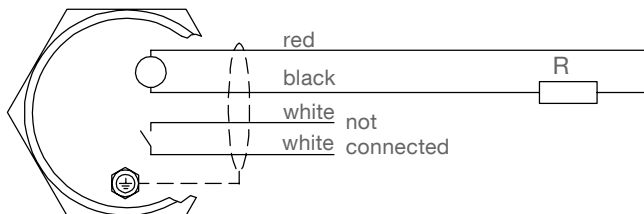

Shield is internal connected to ground.
 It is recommended to use a shielded cable for stable measurement.

Supply: 12 - 33V DC 10 - 30V DC intrinsic safe* Polarity determines output logic, see table below
*For intrinsic safe operation an intrinsic safety barrier is required. Ratings U_i I_i P_i C_i L_i of power supply: see instruction manual.

$$R_{\max} = (V_{\text{supply}} - 12 \text{ V}) / 20 \text{ mA}$$

Example: 24 V supply allows R_{\max} of 600 Ohms

Output logic

	Low level		High level	
Yellow LED	○	☀	☀	○
Status	FSL	FSH	FSL	FSH
Supply polarity (cable colour)	red + black -	red - black +	red + black -	red - black +
Red LED	○	☀	☀	○
Solid state switch				
4/ 20 mA loop	4 mA	20 mA	20 mA	4 mA

FSL = Fail safe low FSH = Fail safe high

Protection of Solid State Switch

Observe a Protection diode in case of connecting an external relay to the Solid state switch

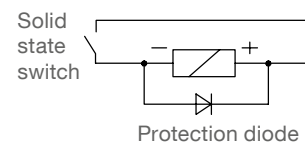

Electrical installation

Enclosure Version

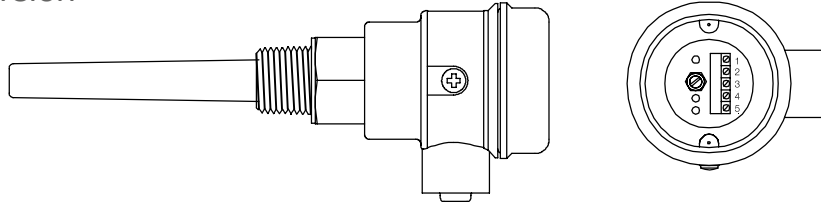

Operation with solid state switch/ relay

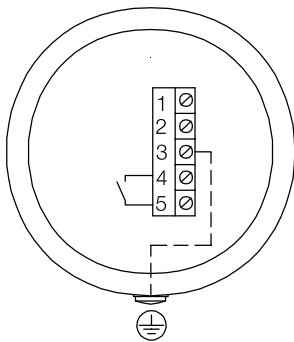

Terminal 3 is internal connected to ground. It is recommended to use a shielded cable for stable measurement.

Terminal 1, 2	Terminal 3	Terminal 4, 5
Supply: 12 - 33 V DC 10 - 30 V DC intrinsic safe* Polarity determines output logic, see table below	cable shield connection connect to ground	Output: Solid state switch* Present with stainless steel process connection. Observe protection (see below). Max. 30 V DC/30 V AC, 82 mA, limited to 30 V DC/ 16 V AC, 82 mA in wet locations Relay Present with PPS process connection. Intrinsic Safety operation not available. Max. 60 V DC or 30 V AC; limited to 30 V DC/ 16 V AC in wet locations, Max. 1 A, 60 W
* For intrinsic safe operation an intrinsic safety barrier is required. Ratings U_i I_i P_i C_i L_i of power supply and solid state switch: see instruction manual.		

Operation with 4/20 mA loop

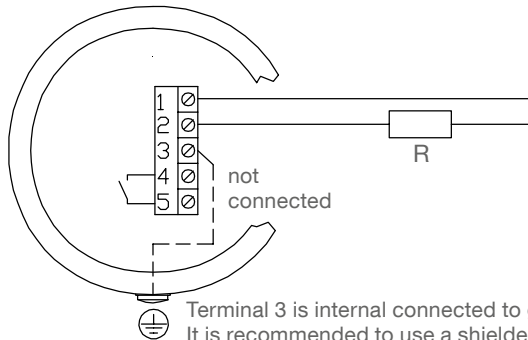

Terminal 3 is internal connected to ground. It is recommended to use a shielded cable for stable measurement.

$$R_{max} = (V_{supply} - 12 V) / 20 mA$$

Example: 24 V supply allows R_{max} of 600 Ohms

Supply: 12 - 33V DC 10 - 30V DC intrinsic safe* Polarity determines output logic, see table below * For intrinsic safe operation an intrinsic safety barrier is required. Ratings U_i I_i P_i C_i L_i of power supply: see instruction manual.
--

Output logic

Yellow LED				
Status	FSL	FSH	FSL	FSH
Supply polarity (Terminal)	1 + 2 -	1 - 2 +	1 + 2 -	1 - 2 +
Red LED				
Solid state switch				
4/ 20 mA loop	4 mA	20 mA	20 mA	4 mA

FSL = Fail safe low FSH = Fail safe high

Protection of Solid State Switch

Observe a Protection diode in case of connecting an external relay to the Solid state switch

